



Safe and approved storage of aggressive and flammable hazardous substances in working areas

Function / construction:

- **robust construction and longevity:** triple hinged door, body made of powder-coated sheet steel, safety elements assembled outside the cabinet for increased protection against corrosion
- **two in one:** 2 compartments (vertical separation) allow the storage of flammable liquids and aggressive hazardous materials in one cabinet
- **user-friendly and safe (folding door compartment):** door open arrest system (standard), convenient and safe removal or storage of containers

- **no unauthorised use:** doors lockable with profile cylinder (integration in an existing locking system possible) / cylinder lock

Available equipment

- Compartment for the storage of flammable liquids
- shelves with load capacity of 75 kg
- tray shelves with load capacity of 150 kg
- perforated insert useable as storage area
- storage box
- Compartment for the storage of aggressive, non flammable hazardous materials
- metal-free tray shelves and collecting sumps

Combi safety storage cabinet

K-PHOENIX-30 model K30.197.120.MV.FWAS

in Light grey (RAL 7035), interior equipment with 3 x shelf, 1 x perforated insert, 1 x bottom collecting sump (sheet steel powder-coated), 4 x tray shelf (PP)

Order No. 30342-001-30344 4

Left compartment



Right compartment



Easy transport

With integrated transport base for an easy in-house transport



Bottom collecting sump

High storage capacity, optimal for the storage of larger containers, safe collection of leakages



Shelf

Height adjustable (32 mm increments), with 30 mm upstand



Extraction unit

Safe ventilation of safety storage cabinets

plug-in – fast and easy to install

Further information and products from page 397

Order No. 14218 2



Drawers

High storage capacity
Ideal for the storage of small containers



Combi safety storage cabinet

K-PHOENIX-30 model K30.197.120.MV.FWAS

in Light grey (RAL 7035), interior equipment with 3 x shelf, 1 x perforated insert, 1 x bottom collecting sump (sheet steel powder-coated), 6 x tray shelf (PP)

Order No. 30342-001-30345



Hazardous substances center

K-PHOENIX-30 model K30.197.120.MC.FWAS

in Light grey (RAL 7035), interior equipment with 1 x storage box, 2 x shelf, 1 x perforated insert, 1 x bottom collecting sump (sheet steel powder-coated), 4 x tray shelf (PP)

Order No. 30343-001-30758

Order example - how to order correctly



Model	Information / equipment	Order No.
K30.197.120.MV.FWAS	without interior equipment, with vertical dividing wall	30342
K30.197.120.MC.FWAS	without interior equipment, hazardous substances center (including lockable storage box on shelf)	30343

Body colour	Door colour	Order No.
Light grey RAL 7035	Light grey RAL 7035	001

Interior equipment packages (can only be ordered in combination with the cabinet) K30.197.120.MV.FWAS	Material	Order No.
left: 3x shelf, 1x perforated insert, 1x bottom collecting sump (V=270L) right: 4x tray shelf (V=18.0L)	sheet steel powder-coated RAL 7035, PP grey	30344
left: 3x shelf, 1x perforated insert, 1x bottom collecting sump (V=270L) right: 6x tray shelf (V=18.0L)	sheet steel powder-coated RAL 7035, PP grey	30345
left: 3x shelf, 1x perforated insert, 1x bottom collecting sump (V=270L) right: 4x tray shelf (V=11.0L)	stainless steel, PP grey	30346
left: 3x shelf, 1x perforated insert, 1x bottom collecting sump (V=270L) right: 6x tray shelf (V=11.0L)	stainless steel, PP grey	30347







Interior equipment packages (can only be ordered in combination with the cabinet) K30.197.120.MC.FWAS	Material	Order No.
left: 1x storage box, 2x shelf, 1x perforated insert, 1x bottom collecting sump (V=270L) right: 4x tray shelf (V=18.0L)	sheet steel powder-coated RAL 7035, PP grey	30758
left: 1x storage box, 2x shelf, 1x perforated insert, 1x bottom collecting sump (V=270L) right: 6x tray shelf (V=18.0L)	sheet steel powder-coated RAL 7035, PP grey	30759
left: 1x storage box, 2x shelf, 1x perforated insert, 1x bottom collecting sump (V=270L) right: 4x tray shelf (V=11.0L)	sheet steel powder-coated, stainless steel, PP grey	30760
left: 1x storage box, 2x shelf, 1x perforated insert, 1x bottom collecting sump (V=270L) right: 6x tray shelf (V=11.0L)	sheet steel powder-coated, stainless steel, PP grey	30761



























Individual configuration of model **K30.197.120.MV(MC).FWAS**

 Model	Information / equipment	W x D x H (mm)	Order No.
K30.197.120.MV.FWAS	without interior equipment, with vertical dividing wall	1202 x 598 x 1968	30342
K30.197.120.MC.FWAS	without interior equipment, hazardous substances center (including lockable storage box on shelf)	1202 x 599 x 1968	30343

 Body colour	Door colour	Order No.
Light grey RAL 7035	Light grey RAL 7035	001 

 Interior equipment individual parts (right comp.)	Material	W x D x H (mm)	 ¹⁾	 ²⁾	 ³⁾	Order No.
 tray shelf	panel/PP melamine resin-coated grey	407 x 468 x 80*	25.00	18.00	16.36	30341 

 Interior equipment individual parts (left comp.)	Material	W x D x H (mm)	 ¹⁾	 ²⁾	 ³⁾	Order No.
 shelf	sheet steel powder-coated RAL 7035 stainless steel	465 x 497 x 40* 465 x 497 x 40*	75.00 75.00			30311  30312 
 tray shelf	panel/PP melamine resin-coated grey	407 x 468 x 80*	25.00	18.00	16.36	30341 
 perforated insert	sheet steel powder-coated RAL 7035 stainless steel	420 x 439 x 60 425 x 439 x 60	75.00 75.00			5555  5776 
 bottom collecting sump	sheet steel powder-coated RAL 7035 stainless steel	504 x 478 x 120* 504 x 478 x 120*		27.00 27.00	24.55 24.55	9445  10533 
 storage box, left hinged	sheet steel powder-coated RAL 7035	380 x 420 x 360				30029 
 storage box, right hinged	sheet steel powder-coated RAL 7035	380 x 420 x 360				30030 
 pipe lead-through	sheet steel powder-coated RAL 7035	182 x 104 x 48				30035 
 box for chemicals	PP blue	410 x 300 x 260		18.00	16.36	30038 
 document holder, DIN A5	polystyrene					30793 

 Accessories	Order No.
extraction unit without exhaust air monitoring	14218 

* usable storage space W x D [mm]

1) load capacity [kg], 2) retention capacity [ltr], 3) maximum container volume in the cabinet [ltr]

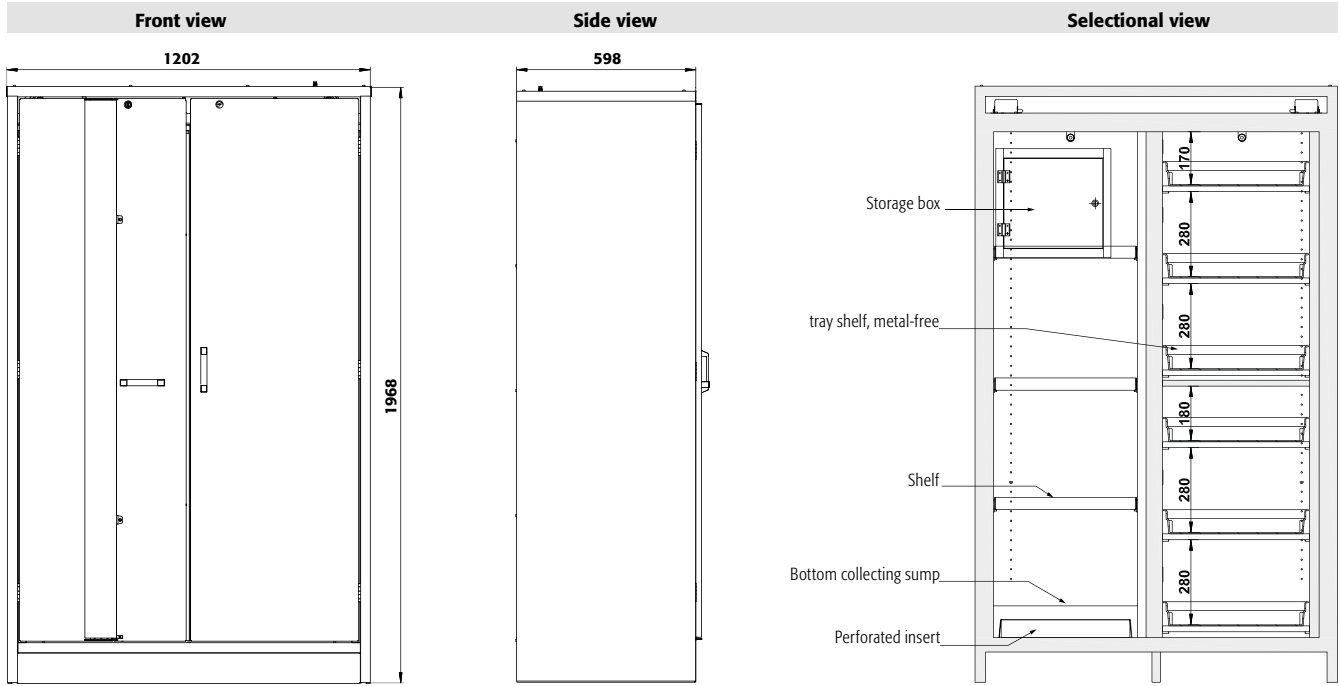

K-LINE

Technical data		K30.197.120.MV.FWAS(MC.FWAS)	
External dimensions W x D x H	mm	1202 x 598 x 1968	
Internal dimensions W x D x H	mm	left: 532 x 519 x 1691 right: 486 x 519 x 1691	
Weight without interior equip.	kg	330	
Air change 10 times	m ³ /h	9	
Diff. pressure (air change 10 times EK5/AK4)	Pa	5	
Diff. pressure (air change 10 times)	Pa	5	
Maximum load	kg	600	
Distributed load	kg/m ²	484	
Transport base			
Entry width transport base	mm	1071	
Entry height transport base	mm	100	

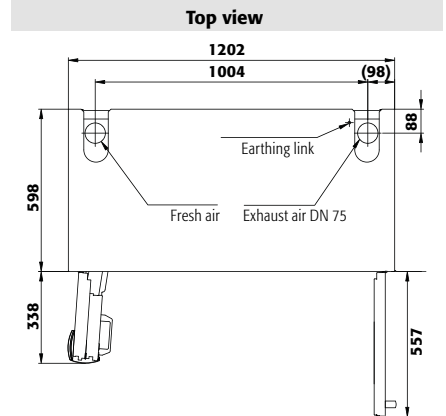

K30.197.120.MV(MC).FWAS standard storage heights for shelves (left compartment)									
Shelves/number	9	8	7	6	5	4+1	4	3	2
Distance ④ (mm)							365		
Distance ③ (mm)							285	395	
Distance ② (mm)							315	380	
Distance ① (mm)							315	410	

K30.197.120.MV(MC).FWAS standard storage heights for shelves (right compartment)									
Shelves/number	9	8	7	6	5	4+1	4	3	2
Distance ⑥ (mm)				170					
Distance ⑤ (mm)				280					
Distance ④ (mm)				280			375		
Distance ③ (mm)				180			380		
Distance ② (mm)				280			380		
Distance ① (mm)				280			380		

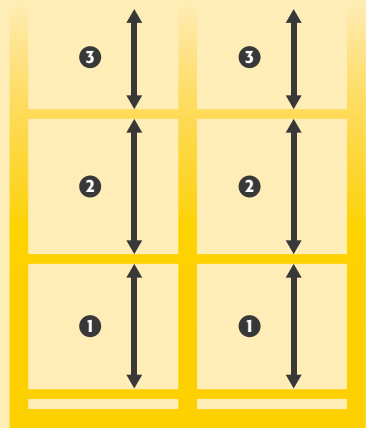



WolfLabs

Pricing on any accessories shown can be found by keying the part number into the search box on our website.

The specifications listed in this brochure are subject to change by the manufacturer and therefore cannot be guaranteed to be correct. If there are aspects of the specification that must be guaranteed, please provide these to our sales team so that details can be confirmed.

www.wolflabs.co.uk

Tel : 01759 301142

Fax : 01759 301143

sales@wolflabs.co.uk

Please contact us if this literature doesn't answer all your questions.